



C6 Series

C6B & C6R Installation & Service Manual



For C6 Series Controls with the B11 Circuit Board

Revision 08.22

End User Disclaimer

End User Disclaimer:

United Spa Controls systems have absolutely no end user serviceable parts. United Spa Controls does not authorize attempts by the spa owner/user to install or repair/service any United Spa Controls products.

Non-qualified users should never open or remove covers, as this will expose dangerous voltage points and other serious risks.

Non-qualified users should not attempt to make changes to the topside's programming, as mis-programming can result in malfunction or possible damage.

Please contact your dealer or a locally licensed service center for service and technical support.

This installation and service manual is provided solely to aid qualified spa service technicians in installing, setting up, and troubleshooting spas with United Spa Controls systems.

Table of Contents

End User Disclaimer	1
Electrical Installations	3
120V Cord and Plug Connected	3
120V Permanently Connected	4
240V Installation - 4-Wire	5
240V Installation - 3-Wire (No Neutral)	6
Control Box Installation	7
Finishing Installation	9
Troubleshooting	10
Important Troubleshooting Information	10
Incoming Voltage	11
Troubleshooting Test Points	13
Transformer & 1A Glass Fuse	14
Low Voltage Circuit & Light Circuit	15
Pumps/Blower/Ozone	16
Heating Circuit	17
Replacing Relays	18
Wiring Diagram	19
C6 Series Specs	21
Warranty	22

Electrical Installations

120V Installation (Cord and Plug Connected Units):

Equipment Modules provided with a factory installed power cord are to be plugged into a grounding type, 120 volt, receptacle.

The connection of the plug to a 240 volt service will cause the Equipment Module to operate improperly, create the potential for an electrical hazard, and will void the warranty.

The electrical supply for cord and plug connected units must include a suitably rated Ground Fault Circuit Interrupter (GFCI) in compliance with Article 680-42 of the National Electrical Code. ANSI/NFP70. No other electrical appliance or fixture should be used on this circuit.

- Use only dedicated electrical line with 20 amp breaker.
- Do not use an extension cord.
- Always use a weatherproof covered receptacle.
- Do not bury the power cord.

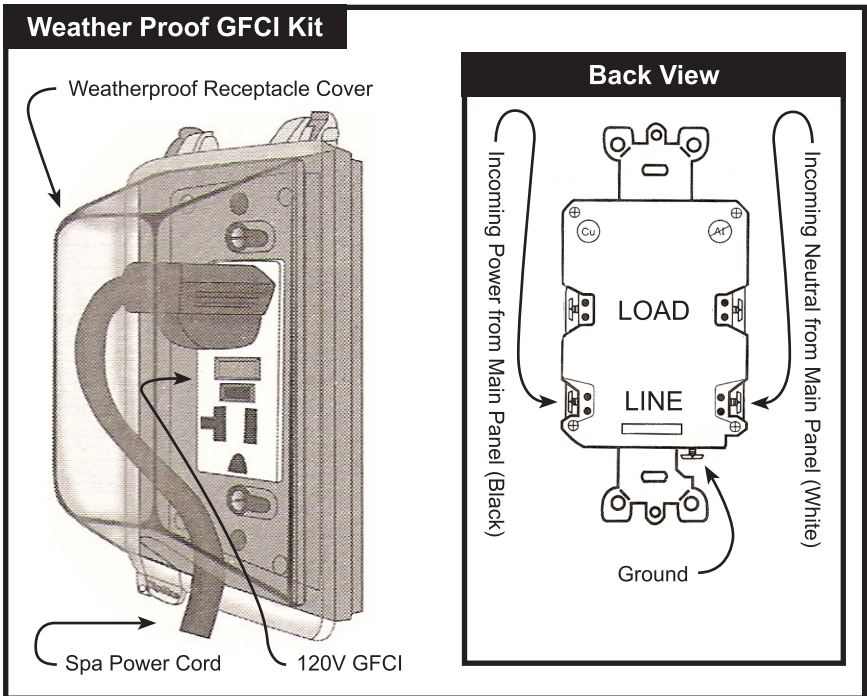

Electrical Installations

120V Installation (Permanently Connected Units):

Units to be operated at 120 volt must have all electrical connections accomplished by a qualified electrician in accordance with the National Electrical Code or the Canadian Electrical Code, and other electrical codes at the time of installation. All connections must be made with copper conductors. The conductors and circuit breaker must be sized to accommodate the total amperage load as specified on the Equipment Module data label. Equipment Modules installed for 120 volt operation require a two wire electrical service, plus ground. Line 1 (black), Neutral (white), and Ground (green).

The disconnecting means must be readily accessible to the tub occupant but installed at least 5 feet (1.5 m) from tub water. The electrical supply for permanently connected units must include a suitably rated Ground Fault Circuit Interrupter (GFCI) in compliance with Article 680-42 of the National Electrical Code. ANSI/NFP70. No other electrical appliance or fixture should be used on this circuit.

Weather Proof GFCI Kit

Weatherproof Receptacle Cover

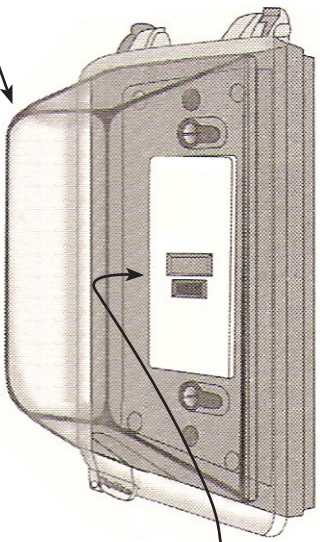

120V GFCI

Back View

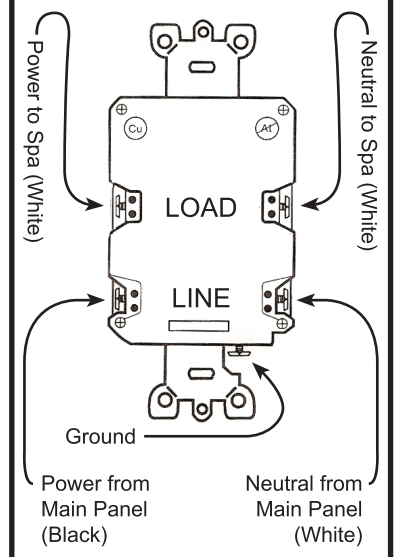

Electrical Installations

240V Installation (4 wire - Line 1, Line 2, Neutral, and Ground):

Units to be operated at 240 volt must have all electrical connections accomplished by a qualified electrician in accordance with the National Electrical Code or the Canadian Electrical Code, and other electrical codes at the time of installation. All connections must be made with copper conductors. The conductors and circuit breaker must be sized to accommodate the total amperage load as specified on the Equipment Module data label. Equipment Modules installed for 240 volt operation require a three wire electrical service, plus ground. Line 1 (black), Line 2 (red), Neutral (white), and Ground (green).

The disconnecting means must be readily accessible to the tub occupant but installed at least 5 feet (1.5 m) from tub water. The electrical supply for permanently connected units must include a suitably rated Ground Fault Circuit Interrupter (GFCI) in compliance with Article 680-42 of the National Electrical Code. ANSI/NFP70. No other electrical appliance or fixture should be used on this circuit.

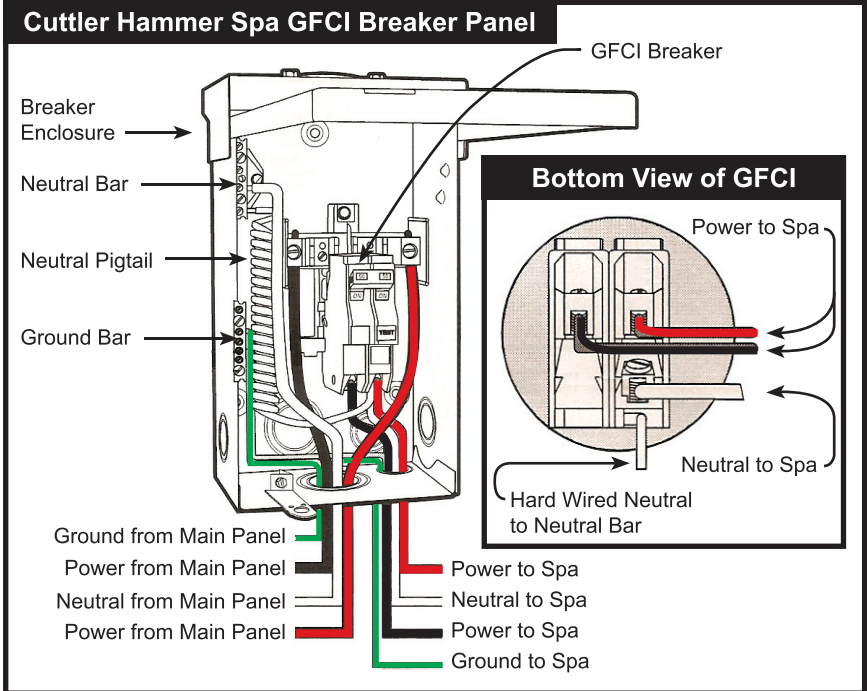

Electrical Installations

240V Installation (3 wire - Line 1, Line 2, and Ground):

Units to be operated at 240 volt must have all electrical connections accomplished by a qualified electrician in accordance with the National Electrical Code or the Canadian Electrical Code, and other electrical codes at the time of installation. All connections must be made with copper conductors. The conductors and circuit breaker must be sized to accommodate the total amperage load as specified on the Equipment Module data label. Equipment Modules installed for 240 volt operation require a two wire electrical service, plus ground. Line 1 (black), Line 2 (red), and Ground (green).

The disconnecting means must be readily accessible to the tub occupant but installed at least 5 feet (1.5 m) from tub water. The electrical supply for permanently connected units must include a suitably rated Ground Fault Circuit Interrupter (GFCI) in compliance with Article 680-42 of the National Electrical Code. ANSI/NFP70. No other electrical appliance or fixture should be used on this circuit.

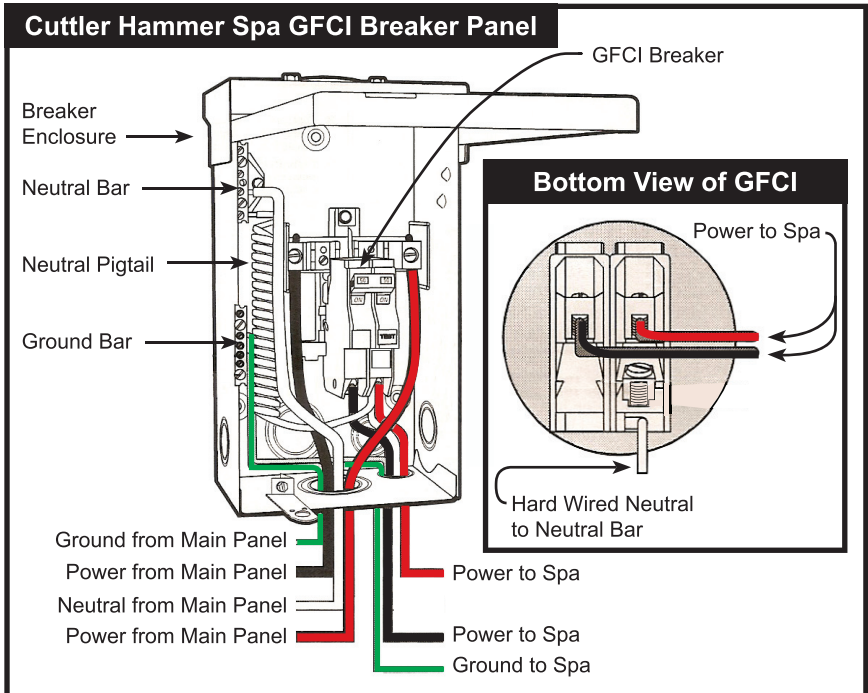

Control Box Installation

Mounting and Plumbing Considerations

The C6 control box is made for above ground portable hot tubs. As such it is an indoor unit, meant to be mounted inside of the portable hot tub's enclosure. Water may flow through the heater in either direction, as long as the water is being pushed through it (plumbed up to the discharge of the pump). Plumbing the heater up to the suction of the pump will not allow the heater to operate.

Temperature Sensor Installation

The C6 control box comes with a 1/4" diameter temperature sensor. Its probe is meant to be installed into a thermowell which itself should be installed mid-water level in the hot tub to provide the most accurate temperature reading. After installing the temperature sensor probe, be sure to plug the connector on the end of the cable into the temperature sensor receptacle on the control box. The included sensor is carefully calibrated to its cable's length, and therefore must in no way be altered or shortened/lengthened.

Equipment Connection

The **Circulation Pump** receptacle is for circulation pumps (rated 2A or less). If your pump does not match this description it must be connected to the **Pump-1** receptacle and used as Pump-1.

The C6 control uses the red wire for low-speed operation of Pump-1 and Pump-2. Connecting a single speed pump as Pump-1 for both operating the jets and heating/filtration is not recommended, but if you must use a single speed pump for both, you must connect the red and black wires of the pump cable together up to the high speed terminal on the back of the pump's motor to both operate jets and heat/filter.

If you are connecting an air blower or third pump to the **Pump-3** receptacle, then if there is a two speed Pump-2 it *must* be wired for single speed (no red wire) operation at the back of the motor.

Control Box Installation

The **Pump-1**, **Pump-2**, and **Pump-3** receptacles are pre-wired for 240V. The **Ozone**, **Circulation Pump**, **Audio**, and **Gas** receptacles are all pre-wired for 120V.

These receptacles are all dyed different colors, and have white wires striped with their respective receptacle's color. To change the voltage of a receptacle simply move it's correspondingly color striped white wire at the power lugs from Neutral to Line 2 to convert to 240V, or from Line 2 to Neutral to convert to 120V.

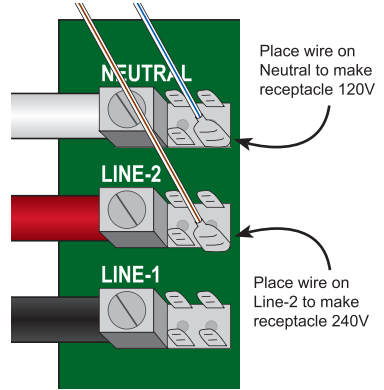

The **Light** receptacle is wired for industry standard 12V lighting, up to 0.9A.

Power Installation

For 4-wire 240V power installations:

As shown, the included dual-voltage transformer's 2-pin AMP plug needs to be connected to the board's 240V receptacle. The incoming Line-1, Line-2, and Neutral wires will need to be connected to the correspondingly labeled power lugs on the circuit board. The ground wire will need to be connected to the ground lug that is fastened to the aluminum enclosure.

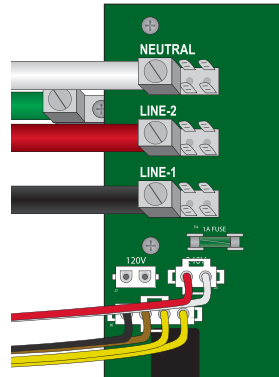

See the following page for information on 3-wire 240V and 120V power installations...

Control Box Installation

For 3-wire 240V power installations:

As shown, the included dual-voltage transformer's 2-pin AMP plug needs to be connected to the board's 240V receptacle. The incoming Line-1 and Line-2 wires will need to be connected to the correspondingly labeled power lugs on the circuit board. The incoming Line 2 will also need to be brought to the Neutral power lug (commonly done with a short jumper wire as illustrated). The ground wire will need to be connected to the ground lug that is fastened to the aluminum enclosure.

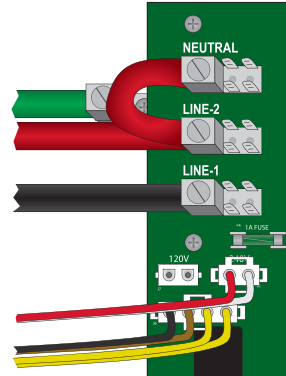

For 120V power installations:

As shown, the included dual-voltage transformer's 2-pin AMP plug needs to be connected to the board's 120V receptacle. The incoming Line-1 and Neutral wires will need to be connected to the correspondingly labeled power lugs on the circuit board, and the incoming Neutral will also need to be brought to the Line 2 power lug on the circuit board (commonly done with a short jumper wire as illustrated). The ground wire will need to be connected to the ground lug that is fastened to the aluminum enclosure.

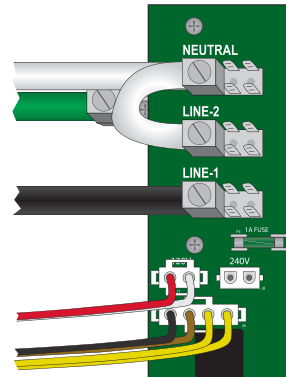

Finishing Installation

After installation of the C6 control box is complete, its time to read through the installation manual and user's guide that comes packaged with the topside control. The installation manual will guide you through installing and programming the topside which completes the installation process.

Important Troubleshooting Information

Warning:

When working on the control box be aware that it may contain high voltage wiring.

Warning:

Always keep your fingers and tools away from the circuit board and any wiring while the power is on. Serious injury may result!

Warning:

Make sure that the power to the control box is shut off before touching any wiring.

When troubleshooting a United Spa Controls system, no matter how minor the issue is, the first things that must be checked are the incoming power to the control board and the output power of the transformer.

You will need to set your multi-meter or voltmeter for AC Volts when testing voltages within the United Spa Controls system. You will only set your multi-meter or voltmeter to DC Volts when testing the IC Regulator Chip.

Once you've completed the incoming voltage and transformer voltage checks as outlined on the next few pages, you can proceed with further diagnosis using the test points and instructions outlined later in this section.

Troubleshooting

Incoming Voltage Checks

Voltage Check for 120V Incoming Power:

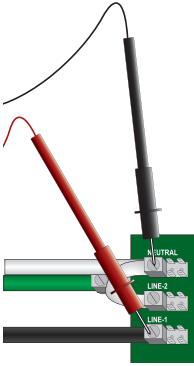

Neutral and Line-1
120VAC (108VAC-132VAC)



Line-2 and Line-1
120VAC (108VAC-132VAC)

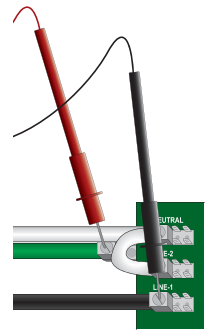

Line-1 and Ground
120VAC (108VAC-132VAC)

120VAC (Range of acceptability: 108VAC to 132VAC) should be read between; Neutral and Line-1, Line-2 and Neutral, and Line-1 and Ground.

Voltage Check for 240V (3-Wire) Incoming Power



Line-2 and Line-1
240VAC (216VAC-264VAC)



Neutral and Line-1
240VAC (216VAC-264VAC)

240VAC (Range of acceptability: 216VAC to 264VAC) should be read between Line-2 and Line-1, and between Neutral and Line-1.

Voltage Check for 240V (4-Wire) Incoming Power

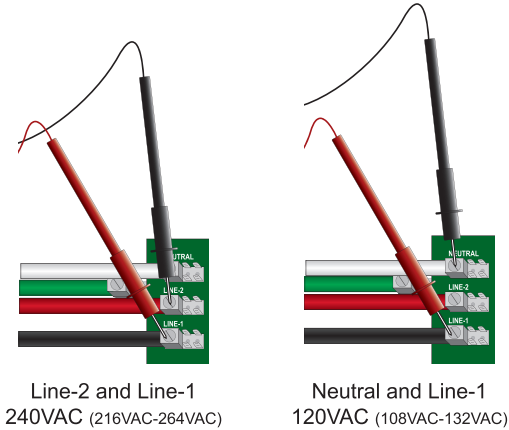

240VAC (Range of acceptability: 216VAC to 264VAC) should be read between Line-2 and Line-1. 120VAC (Range of acceptability: 108VAC to 132VAC) should be read between Neutral and Line-1.

If ANY of the voltages read when checking the incoming power do not fall within the indicated ranges of acceptability, then do not proceed with any further troubleshooting until the incoming power issue is corrected.

Further Troubleshooting

If the system passes the incoming voltage check, the transformer and the circuit board's glass fuse should be tested next. By testing the incoming voltage, and the power to the board (the transformer, and glass fuse), you can proceed with further troubleshooting without possibly missing an underlying power related problem.

The Troubleshooting Test Points outlined on the next page will be referenced throughout the rest of this section in explaining how to test the various internal circuits of the control box. The page after next will explain how to properly test the transformer and circuit board's glass fuse. The pages that follow that will explain troubleshooting the other various circuits of the control box.

Troubleshooting

Troubleshooting Test Points

The following test points will be used when troubleshooting the control box's internal circuits:

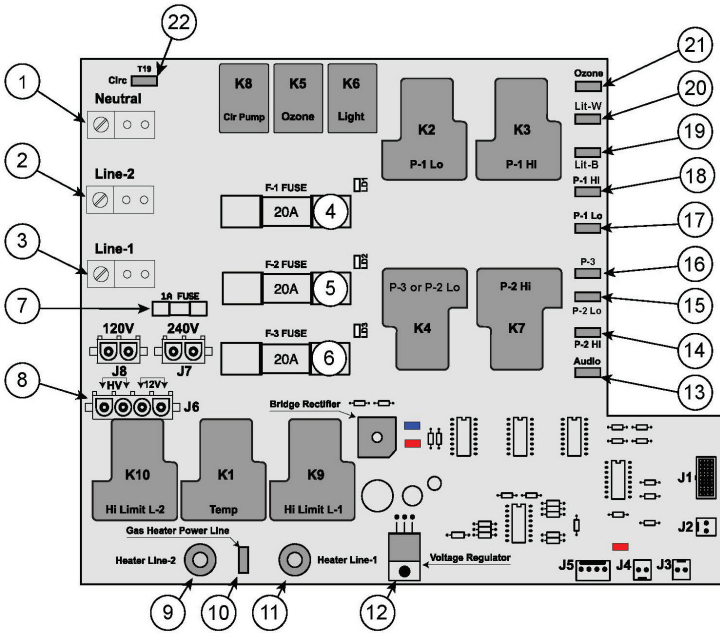

- 1 - Incoming Neutral
- 2 - Incoming Line-2
- 3 - Incoming Line-1
- 4 - 20A Fuse (F1)
- 5 - 20A Fuse (F2)
- 6 - 20A Fuse (F3)
- 7 - 2A Glass Fuse (F4)
- 8 - Transformer Receptacle
- 9 - Heater Line-2
- 10 - T18/Gas Terminal
- 11 - Heater Line-1

- 12 - IC Regulator Chip
- 13 - Audio
- 14 - Pump-2 Hi-Speed
- 15 - Pump-2 Lo-Speed
- 16 - Pump-3
- 17 - Pump-1 Lo-Speed
- 18 - Pump-1 Hi-Speed
- 19 - Light (black wire)
- 20 - Light (white wire)
- 21 - Ozone
- 22 - Circ Pump

Transformer Voltage Checks

The dual-voltage transformers used in United Spa Controls systems have 6 wires, and two plugs. There is a 2-prong AMP plug with a red and white wire, that determines the transformer's input voltage by being plugged into the board's labeled receptacle corresponding to the incoming power supply (120V or 240V). There is also a 4-pin AMP plug, with the a black, a brown wires, and two yellow power wires that carry the voltage to and from the board. It should be possible to slide the pins of your voltmeter/multi-meter into the top of the 4-pin transformer plug (where the power wires enter the 4-pin AMP plug). 240VAC (Range of acceptability: 216VAC to 264VAC) should be read between the black and brown wires when the 2-pin AMP plug is plugged into the 240V receptacle, or 120VAC (Range of acceptability: 108VAC to 132VAC) when the 2-pin AMP plug is plugged into the 120V receptacle. If you are not getting a reading of the incoming power within the acceptable range, and you've confirmed the incoming voltage with the previous voltage checks, then the 1A Glass Fuse (Testing Point 7) should be checked next.

If the incoming voltage checks out, proceed to test the output voltage. 12VAC (Range of acceptability: 12VAC to 14VAC) should be read between yellow wires. If the voltage read between the yellow wires does not fall within the indicated ranges of acceptability, then do not proceed with any further troubleshooting until the transformer has been replaced.

Checking the 1A Glass Fuse

Put one probe of your voltmeter/multi-meter on Line-2 (Testing Point 2), and the other on the LEFT fuse clip of the 1A Glass Fuse (Testing Point 7). You should get a voltage reading equal to the control box's incoming power voltage (240VAC or 120VAC). Leaving one probe on Line-2, move the other probe to the RIGHT fuse clip. You should again get a voltage reading equal to the incoming power voltage, if you do not, then the fuse has blown and needs replacing.

Troubleshooting

Troubleshooting the Circuit Board's Low Voltage Circuit

If the control is non-operational, or the topside display is completely blank, but the incoming voltage, transformer, and glass fuse all test okay, the circuit board's IC Regulator Chip should be tested.

Checking the IC Regulator Chip

Be sure your voltmeter/multi-meter is set to DC Volts to test this component. Place one probe of your voltmeter/multi-meter on the IC Regulator Chip's (Testing Point 12) mounting nut, and the other on the RIGHT most pin coming out of the top of the chip. You should get a voltage reading of approximately 15VDC. If not, the board's bridge rectifier (marked BR1 on the board) has failed and needs to be replaced.

Next, leaving one probe on the mounting nut, move the other probe to the LEFT most pin coming out of the top of the chip. You should get a voltage reading of approximately 5VDC. If not, the IC Regulator Chip itself has failed and needs to be replaced.

Troubleshooting the Light Circuit

With the light turned on at the topside, place one probe of your voltmeter/multi-meter on Testing Point 18 (Light-B) and the other on Testing Point 19 (Light-W). You should get a reading of 12VAC. If you read no voltage, and the incoming power and transformer tested okay, then the light relay has failed. If you read voltage, but the light does not function, then the light bulb itself has failed and needs replacing.

Troubleshooting the Pumps/Blower/Ozone

If one or more of the pumps/blower/ozone are non-operational, re-check that the code settings have been programmed correctly for the equipment configuration. If programmed correctly, the main fuses and output voltages should be checked.

Checking the Main Fuses

On the B11 board, the Circulation Pump, Pump-1, Audio, and ozone all use the F1 Fuse (Testing Point 4). The Blower, Pump-3, or Pump-2 (Low-Speed) uses the F2 Fuse (Testing Point 5)., while Pump-2 (Hi-Speed) uses the F3 Fuse (Testing Point 6).

The B11 board also features LED lights mounted just above and to the right of each of these three fuses. These LEDs will glow red when a component on it's fuse's circuit is attempting to draw power but the fuse is blown.

To manually test the fuse of the non-operational component: Put one probe of your voltmeter/multi-meter on Line-2 (Testing Point 2) and the other on the LEFT fuse clip of the fuse in question. You should get a voltage reading equal to the control box's incoming power voltage (240VAC or 120VAC). Leaving one probe on Line-2, move the other probe to the RIGHT fuse clip. You should again get a voltage reading equal to the incoming power voltage, if you do not, then the fuse has blown and needs replacing.

Checking the Output Voltages

The output power pin of each component are located at the top right of the circuit board (Testing Points 13-17, and 20). To test, activate the desired component that is being tested. Pump-1, Pump-2, and Pump-3 can be activated by simply pressing their corresponding button on the topside. The ozonator is only activated during filtration cycles, so you'll have to force the system to filter to test the ozone power. Activation is usually not necessary for the Circ pump as it's generally constantly powered. Next place one probe of your voltmeter/multi-meter on Line-2 (Testing Point 2), and the other on the testing point for the component in question. If the fuse checks out, but no voltage is read on the power terminal of the component in question (while the control is of course calling for that component to run), then the relay for that component has failed.

Troubleshooting

Troubleshooting the Heating Circuit

If the heater is non-operational or the unit is not heating properly, re-check that the code settings have been programmed correctly for the hot tub's heating configuration. If programmed correctly, the heating circuit should be tested.

Testing the Heating Element

To test the heating element, you must first make sure the topside is calling for heat (The display should be flashing the heat message - HEt). Then place one probe of your voltmeter/multi-meter on Testing Point 11 (Heater Line-1), and the other on Testing Point 9 (Heater Line-2). You should get a voltage reading equal to the control box's incoming power voltage (240VAC or 120VAC). If that is the case, but the water is not getting heated, then the heating element has failed/burnt-out/dry-fired.

If the voltage reading was not equal to the incoming power voltage, then proceed with checking the heater relays.

Testing the Heating Relays

Place one probe of your voltmeter/multi-meter on Line-1 (Test Point 3), and the other on Test Point 9 (Heater Line-2). You should get a voltage reading equal to the control box's incoming power voltage (240VAC or 120VAC). If that is the case, proceed to the next test. If you read no voltage, however, then the K10 relay has failed.

If the K10 relay checks out, place one probe of your voltmeter/multi-meter on Line 2 (Test Point 2) and the other on Test Point 10 (T18/Gas Terminal). You should get a voltage reading equal to the control box's incoming power voltage (240VAC or 120VAC). If that is the case, proceed to the next test. If you read no voltage, however, then the K1 relay has failed.

If the K1 relay checks out, place one probe of your voltmeter/multi-meter on Line 2 (Test Point 2) and the other on Test Point 11 (Heater Line-1). You should get a voltage reading equal to the control box's incoming power voltage (240VAC or 120VAC). If you read no voltage, then the K9 relay has failed.

Replacing Relays

Should a relay fail, it can be replaced by anyone qualified to solder or work on electronics. Replacement relays should be available from anywhere United Spa Controls products are sold.

Relay Locations

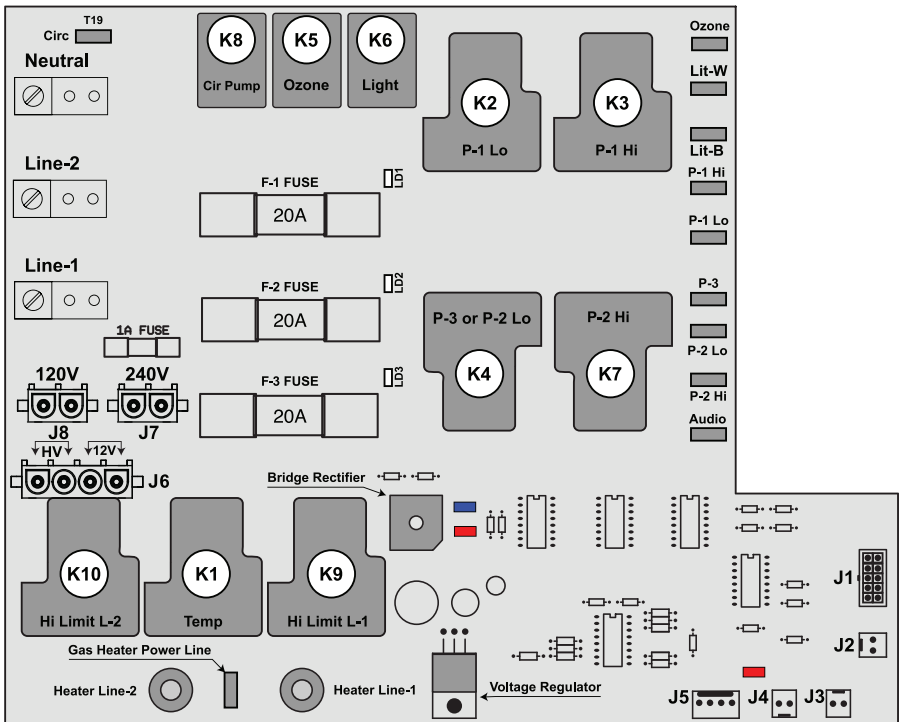

- K1 - Temp Relay
- K2 - Pump-1 Lo-Speed Relay
- K3 - Pump-1 Hi-Speed Relay
- K4 - Pump-2 Low & Aux Relay
- K5 - Ozone Relay

- K6 - Light Relay
- K7 - Pump-2 Hi-Speed Relay
- K8 - Circ Pump Relay
- K9 - Hi-Limit-L1 Relay
- K10 - Hi-Limit-L2 Relay

If the Component is 120V Connect it's
 If the Component is 240V Connect it's

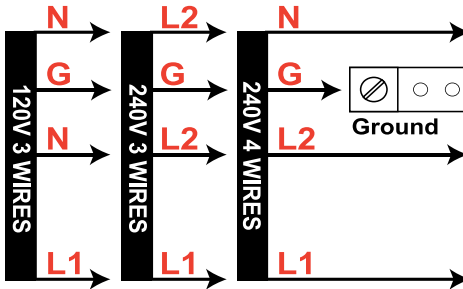

- ▣ USE COPPER CONDUCTORS ONLY
- ▣ EMPLOYER UNIQUEMENT DES CONDUCTEURS DE CUIVRE

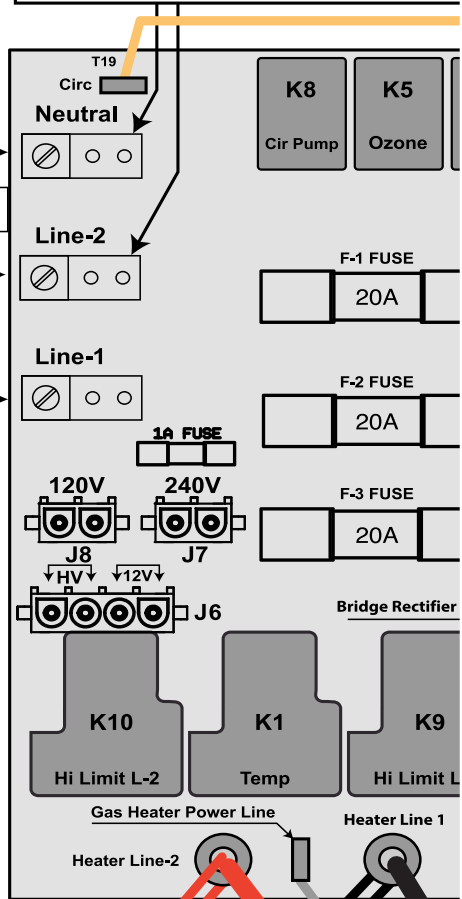
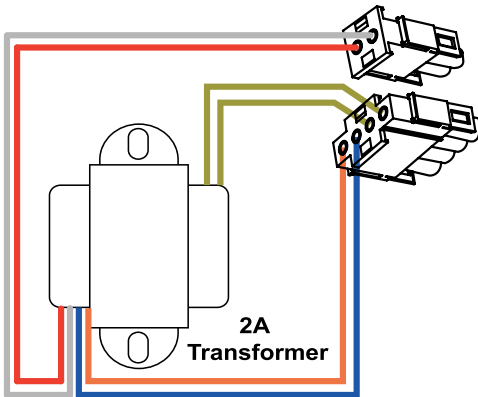

C6R Control
 Heater Module

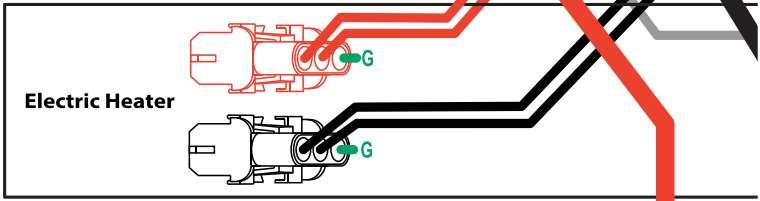

C6B Control
 Heater Module

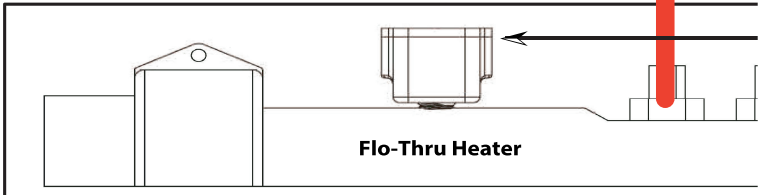

Common Line to the Neutral Lug
 Common Line to the Line-2 Lug

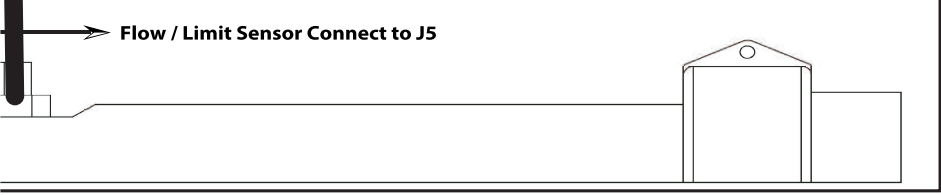
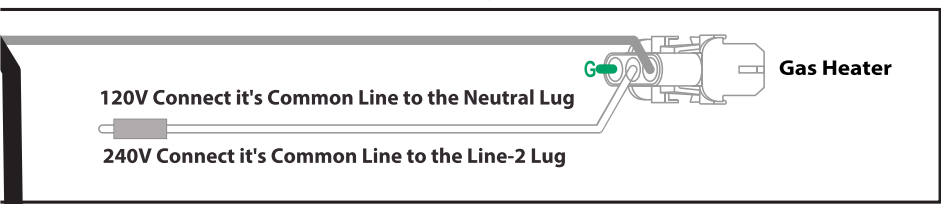
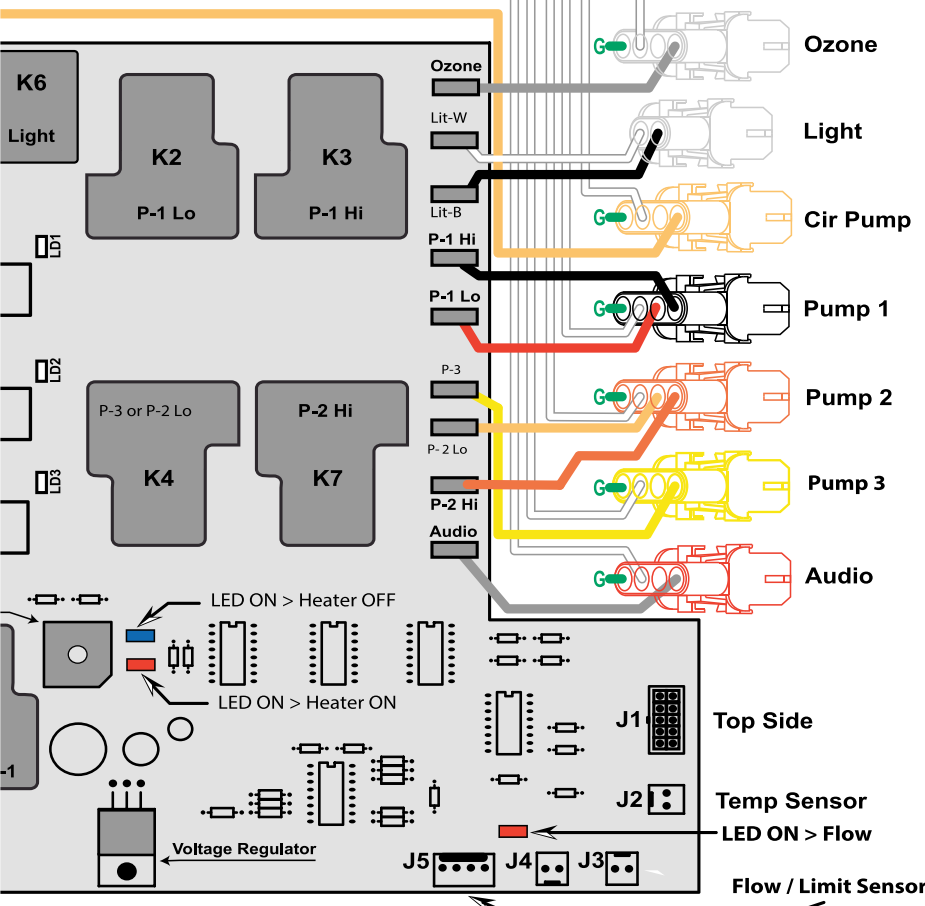
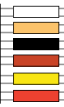

C6 Series Specs

Environmental	
Operational Temperature	-0°F (-18°C) to 145°F (62°C)
Storage Temperature	-2°F (-19°C) to 175°F (79°C)
Humidity	Up to 80% RH, non condensing
Mechanical	
C6B Control Weight	8.35 lbs. (3.78 kg)
C6R Control Weight	5.70 lbs. (2.59 kg)
Low Flow Heater Weight	4.00 lbs. (1.82 kg)
Flow Thru Heater Weight	3.40 lbs. (1.54 kg)
C6B Control Dimensions	12.75"H x 15.50"W x 3.75"D 324mm H x 394mm W x 95mm D
C6R Control Dimensions	9.00"H x 13.50"W x 3.75"D 229mm H x 343mm W x 95mm D
Low Flow Heater Dimensions	3.00"H x 20.75"W x 5.25"D 76mm H x 527mm W x 133mm D
Flow Thru Heater Dimensions	4.50"H x 15.00"W x 3.50"D 114mm H x 381mm W x 89mm D
Enclosure	
C6B Control Box / Heater	Aluminum / Stainless Steel
C6R Control Box / Heater	Plastic / Stainless Steel
Certifications	
(USA & Canada)	UL STD 1563 - 5th Edition CSA C22.2 NO. 218.1
Minimum Heater Flow	
Low Flow Heater	15 GPM Minimum
Flow Thru Heater	25 GPM Minimum
Electrical	
Incoming Power	120V/240V 50/60Hz
-----	-----
Ozone	240V/120V - 1A
Light	12V - .9A
Circulation Pump	240V/120V - 2A
Pump-1	240V/120V - 12A
Pump-2	240V/120V - 12A
Pump-3	240V/120V - 12A
Audio	240V/120V - 4A
Gas Heater	120V/240V - 1A

United Spa Controls One Year Limited Warranty

United Spa Controls warrants, to the original purchaser, the spa control equipment against defects in materials or workmanship for a period of fourteen months from date of manufacture. The obligation of this warranty shall be limited to repairing or replacing the part, which in the opinion of the company shall be proved defective in materials or workmanship. This limited warranty does not include the limitations described below.

Limitations of Coverage: This warranty does not cover failures due to: damage, freezing, power failure, power reduction, unusual atmospheric conditions, rust or corrosion, repairs necessary because of operator negligence, improper re-packaging, and damage incurred in shipping. This warranty does not cover thermostat calibration, plumbing, and expendable items (gaskets, o-rings, filter cartridges).

Acts Invalidating Warranty: This warranty shall be invalid if this equipment has been subjected to alterations, misuse or abuse, improper water chemistry, improper handling, improper installation, repairs (or attempted repairs) which in United Spa Controls' judgment adversely affects the product's performance/reliability, or if the equipment is used for commercial purposes (used for other than single family household purposes). Misuse and abuse shall include application, installation, or operation outside of the environment and limitations for which it was designed. This warranty shall also be invalid if the spa equipment is damaged by earth or ground fill movement, fire, flood, wind, lightning, by act of God, accident, or by intentional, reckless, or negligent acts of any person.

Warranty Performance: All warranty service and/or replacement of parts must be performed by an individual or service company that has been authorized by United Spa Controls. If within the warranty period, any such products shall prove defective, it shall be replaced at United Spa Controls' option as follows: 1) The original retail purchaser shall first contact the point of purchase or the installing dealer, as soon as possible after discovery of the defect, but in no event later than the expiration date of this warranty. Processing claims should be initiated by the point of purchase or the installing dealer. 2) A Return Merchandise Authorization (RMA) form must be completed and submitted to United Spa Controls by the point of purchase or the installing dealer. 3) United Spa Controls will issue an RMA for eligible items that are not out of their warranty period. 4) Defective items may then be packaged along with note that contains the issued RMA number and return shipping information in a box marked with the issued RMA number and shipped to: United Spa Controls, 2480-A N Glassell St, Orange, CA 92865. The customer must pay for all shipping charges and no product shall be returned to United Spa Controls without prior consent. 5) After receipt of the products, supporting documents, and verification of the nature and cause of the defect, United Spa Controls will replace or repair the defective product or issue warranty credit for eligible items at United Spa Controls' option.

Removal charges, re-installation charges, any other associated labor, and freight charges to and from United Spa Controls of the failed part shall be the purchaser's responsibility. Any warranty replacement or repair shall be subject to the terms and condition of this warranty for the remainder of the original period of coverage. United Spa Controls reserves the right to inspect any malfunction or defect on location.

Disclaimers, Legal Remedies: This warranty is limited and shall be in lieu of all other warranties, expressed or implied, including but not limited to, any implied warranty or merchantability or fitness for a particular purpose. There are no other warranties that extend beyond the description of the face hereof. In no event shall United Spa Controls be liable for labor or material charges in connection with removal or replacement of the defective products. United Spa Controls is not liable for the incidental or consequential damages, loss of profit, loss of time, inconvenience and incidental expenses. Some states do not allow the exclusion or limitation of incidental or consequential damages, so the above limitation or exclusion may not apply to you. This warranty gives you specific legal rights, and you may also have other rights, which vary state to state. United Spa Controls reserve the right to change its warranty at any time.



United Spa Controls

2480-A N Glassell St
Orange, CA 92865

Web: UnitedSpaControls.com
E-mail: support@unitedspacontrols.com
Phone: 714-982-0170
Fax: 888-715-0286